

Varenummer: 203150M16100B2TK
 Beskrivelse: E+G Justerfod
 GN 31-50-M16-100-B2-TK
 Note: TK Med møtrik, spændeflade i bunden

Mål

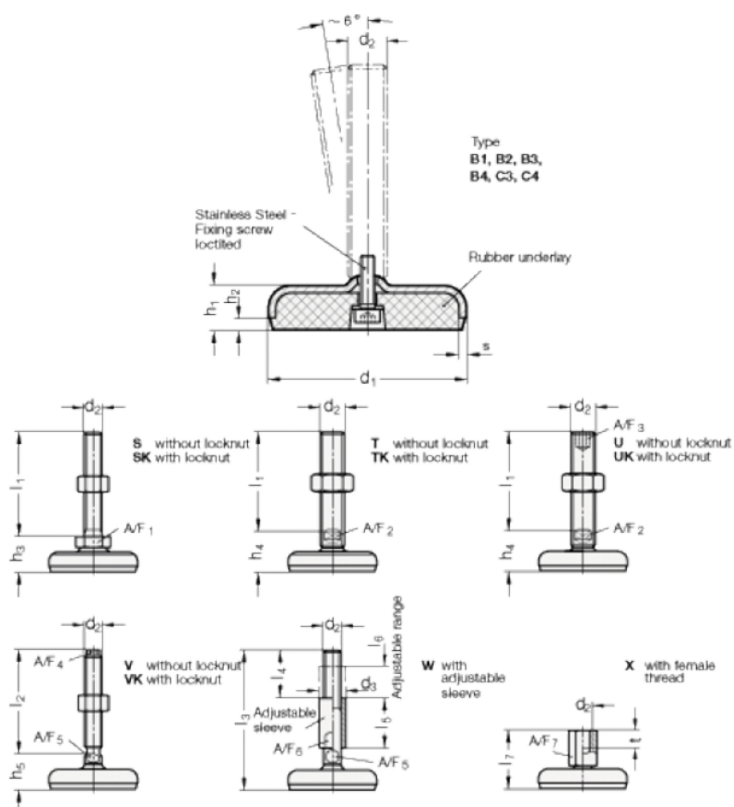

A/F2	= 12
d1	= 50
d2	= 16
h1	= 16
h2	= 3.5
h4 +4.0/0	= 29
l1	= 100
s	= 3